

**EVERDIGM** Attachment

**Breaker**



**Tools that make people move**

Hydraulic Breaker Series  
Turning your job into more value!

## Leading Global Business Partner – EVERDIGM

With the goal to be a total solution provider for tool carriers, EVERDIGM attachments have grown into most reliable attachment manufacturer in Korea and worldwide distribution partners in 70 countries. Meanwhile, company has continuously verified the excellent quality by achieving ISO9001, ISO14001, CE and AEM tool energy rating which realized by high qualified R&D team, efficiency-integrated manufacturing system and goal oriented professional people. With full ranged product line of hydraulic breaker, multiprocessor, pulverizer, compactor, multipurpose grab, quick coupler and other attachments, EVERDIGM attachments fulfill the maximum productivity and durability to construction and demolition job site.

### ● Consider AEM's tool energy rating

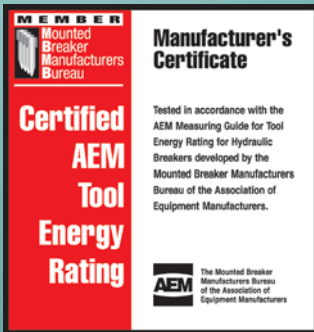

### Why develop the tool energy rating?

Assessing and comparing hydraulic breakers have never been easier or more accurate than the Tool Energy developed by the Mounted Breaker Manufacture Bureau (MBMB) of the AEM. The AEM is the U.S. based international trade group serving the business needs of construction equipment manufacturers and construction services providers. The AEM Tool Energy Rating is accepted by hydraulic breaker manufacturers from Finland, France, Germany, Italy, Japan, Korea, Sweden and the United States. EVERDIGM Corp. has been accredited to self-certify tool energy ratings obtained through test process complying with "AEM Measuring Guide."

### ● Breaker TEST BENCH

AEM Tool Energy Rating test bench simulate actual working condition under controlled situations. Each breaker is tested 25 times while AEM certified observer is monitoring test procedure. Then the each impact energy measured by strain gauges on tool bit is recorded on computer. To be compared with other AEM-MBMB certified breakers all variables like flow, pressure and etc, which affect actual impact energy throughout the tests, are averaged to one specific value. By having this test bench, all breakers manufactured complying with AEM-Tool Energy rating give customers more practical and accurate standard to select breaker. Only breakers that have been tested and certified under AEM regulation can display AEM-MBMB decal.



Test unit installed on impact base connected with strain gauge in tool bit and flow and pressure gauge on hoses port of cylinder



Static calibration test stand for correct measurement



Control console with monitoring panel Power pack to replicate actual situation



## ● Features and benefits

### Proven Working Principle (oil and gas assist)

- Pressurized nitrogen gas is the main power source, to operate with less demand on the carrier's hydraulic system.

### Fewer Components

- Around one-third as its competitor, around 30 to 90 items depending on model
- Easy maintenance
- Dealers need fewer spare parts in inventory
- Easy to rebuild

### Dual speed Control

- Control blow frequency adjusting to hardness of rock

### Anti-blank blow

- Significantly reduces blank blow induced failures

### Underwater application

- Allowing hammer submerged in water from EHB05 & bigger models

### Option

- Auto dispense of lubricating paste, each time hammer is operating
- High temperature & high grade chisel

### Swivel Joint

- Reduces vibration induced hose failure.

### Centralized Lubricating system

- Enable to utilize centralized auto grease system

### Increased life time of dampers and wear plates.

- New type of composite 2 layered damper and wear plate have longer lifetime than conventional material. This gives longer maintenance interval.

### Rugged Construction

- Jigsaw shaped main bracket design achieves better resilience from external force. This ensure sound and long lasting body structure.

## ● Advanced Technology

### Through bolt

- Reduces internal torsion stress to increase fastener life

### Full box enclosure

- No rigid side bolts
- Low maintenance cost
- Extremely durable welded structure
- Reduces noise
- Hammer is completely protected and quieter
- Perfect sealed enclosure by dust Protector & seal plugs (premium series only)

### Wide and light-weight cover

- Noise insulation
- Dust protection, Easy maintenance

### Easy maintenance

- Fewer components
- Wide and appropriate openings

### High quality working tool

- Optimized by high grade steel and heat treatment

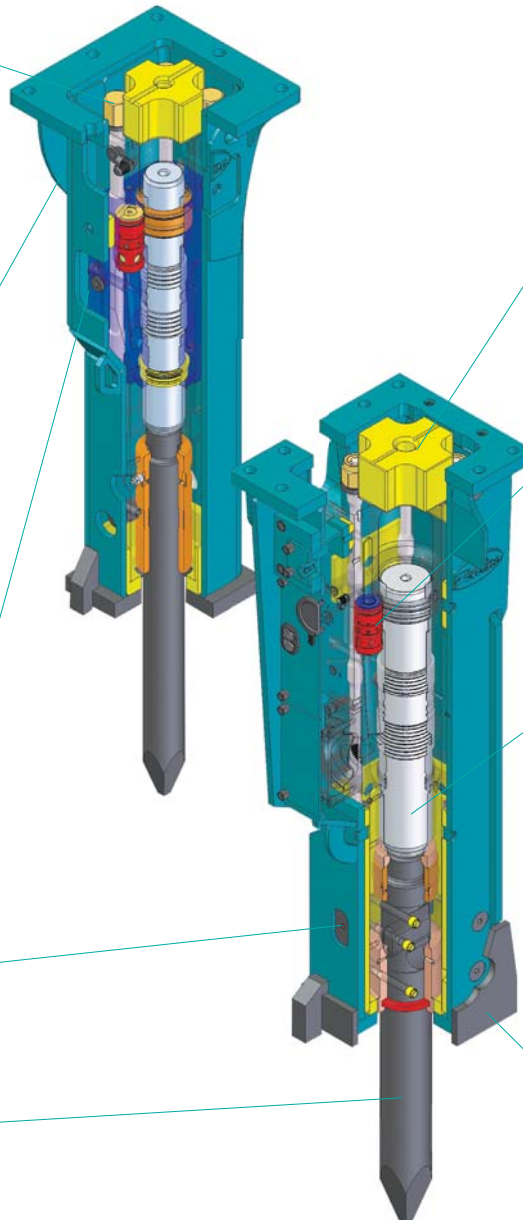

### Perfect cushion damper

- Optimal damping system made of high quality elastomer
- Minimizing recoil shock induced by impact
- Reduces noise and vibration

### Unique valve design

- Lessens pressure fluctuation
- Less damage on carrier's pump

### Long piston stroke

- Maximizes impact energy
- Minimizes recoil
- Eliminates mechanical springs
- Special heat-treated and hardened piston

### High pressure accumulator (EHB17 and larger)

- Eliminates pressure fluctuation
- Increases impact power



### Hardened rock dragger

- Resisting wear and abrasion

# Prime series BA

Prime series are silenced type breakers that developed for environment and human health according to international trend of noise restriction. By wearing a hard boots of reinforced rock dragger and bracket, prime series provides much innovative durability with maximum power than ever. The benefits of this series are dual speed control system, hard boots (EHB13 and larger), anti blank blow system, auto stop & auto start and single high pressure accumulator (EHB17 and larger)



# Standard series NA

The new design and color of power cell have been adapted for this standard series to improve protection of power cell in non-box enclosure bracket. Round open and long side brackets offer not only access for easy maintenance, but also better protection of power cell.



Tools that make people move



### Skidsteer series

# SL

Skidsteer series are developed for skidsteer loader to meet the market requirement of higher impact energy and optimal performance

### Backhoe series

# NL





Backhoe series are developed for backhoe loader to meet the required design for transportation



# Tools that make people move



## Specification

 Items	 Items	 Items	 Items	Unit	EHB008	EHB01	EHB02	EHB03
Working Weight <sup>1)</sup>	Peso De Trabajo	Poids En Ordre De Marche	Betriebsgewicht	kg				
-Prime(BA)	-Prime(BA)	-Prime(BA)	-Erstklassige Ausführung(BA)		80	121	121	152
-Standard(NA)	-Standard(NA)	-Standard(NA)	-Standard(NA)		79	121	121	150
-Standard(NL)	-Standard(NL)	-Standard(NL)	-Standard(NL)					
Required oil flow	Caudal De Aceite Requerido	Débit D'huile nécessaire	Erforderliche Ölmenge	lpm	12-30	15~25	20~35	25~35
Operating Pressure	Presion De Trabajo	Puissance d'entrée(max)	Betriebsdruck	bar	100~130	100~130	100~130	100~130
Input Power(max.)	Fuerza input	Nombre De Frappe A La minute	Leistungsaufnahme(max.)	kw	6.5	5.4	7.6	7.6
Blow Frequency	Frecuencia De impacto	-Basse vitesse	Energie-Rückgewinnung	bpm				
-Low speed mode	-Baja velocidad	-Haute vitesse	-Niedrige Schlagzahl					
-High speed mode	-Alta velocidad	Classe D' énergie de frappe	-Hohe Schlagzahl		550~1,300	700~1,200	700~1,200	550~1,000
Impact Energy <sup>1)</sup> (actual)	Energia De impacto	Porteur indiqué	Schlagenergie	joule				
-Low speed mode	-Baja velocidad	-Basse vitesse	-Niedrige Schlagzahl					
-High speed mode	-Alta velocidad	-Haute vitesse	-Hohe Schlagzahl		110	180	200	300
Tool Shank diameter	Diametro De La Punta	-Diamètre De L'outil	Werkzeughdurchmesser	mm	42	45	45	50
Applicable Carrier Weight	Excavadora Indicada	Porteur indiqué	Baggengewicht	tonne	0.6~1.5	0.7~2.5	1.0~4.0	1.5~4.5
Standard Feature	Carctersticas Basicas	Equipment Standard	Serienmäßige Ausstattung					
-Dual speed	-Doble velocidad	-Vitesse dual	-Dual speed					
-Auto stop/Auto start	-Paro Automatico/Inicio Automatico	-Arrêt et démarrage automatique	-Auto stop/Auto start					
-Anti-Blank Blow	-Sistema Contra Golpes en vacio	-Système d'amortissement des Frappes à vide	-Leerschlagsicherung					
-Hard Boots	-Carcaza inferior Reforzada	-Bas du caisson renforcé	-Hardox Räumklötze					
Available Options	Caracteristicas Opcionales	Options disponibles	Verfügbare Varianten					
-Auto Greasing Kit	-Sistema de Auto Engrase	-Kit de graissage automatique	-Zentralschmieranlage					

Note : 1) Total Weight including standard tool, standard mounting adapter and spacers but excluding hydraulic hoses, fittings and mounting pins.

2) Measured in accordance with the certified test procedure which complies with the AEM(formerly CIMA) tool energy rating for hydraulic breakers. Materials and specifications are subject to change without prior notice.



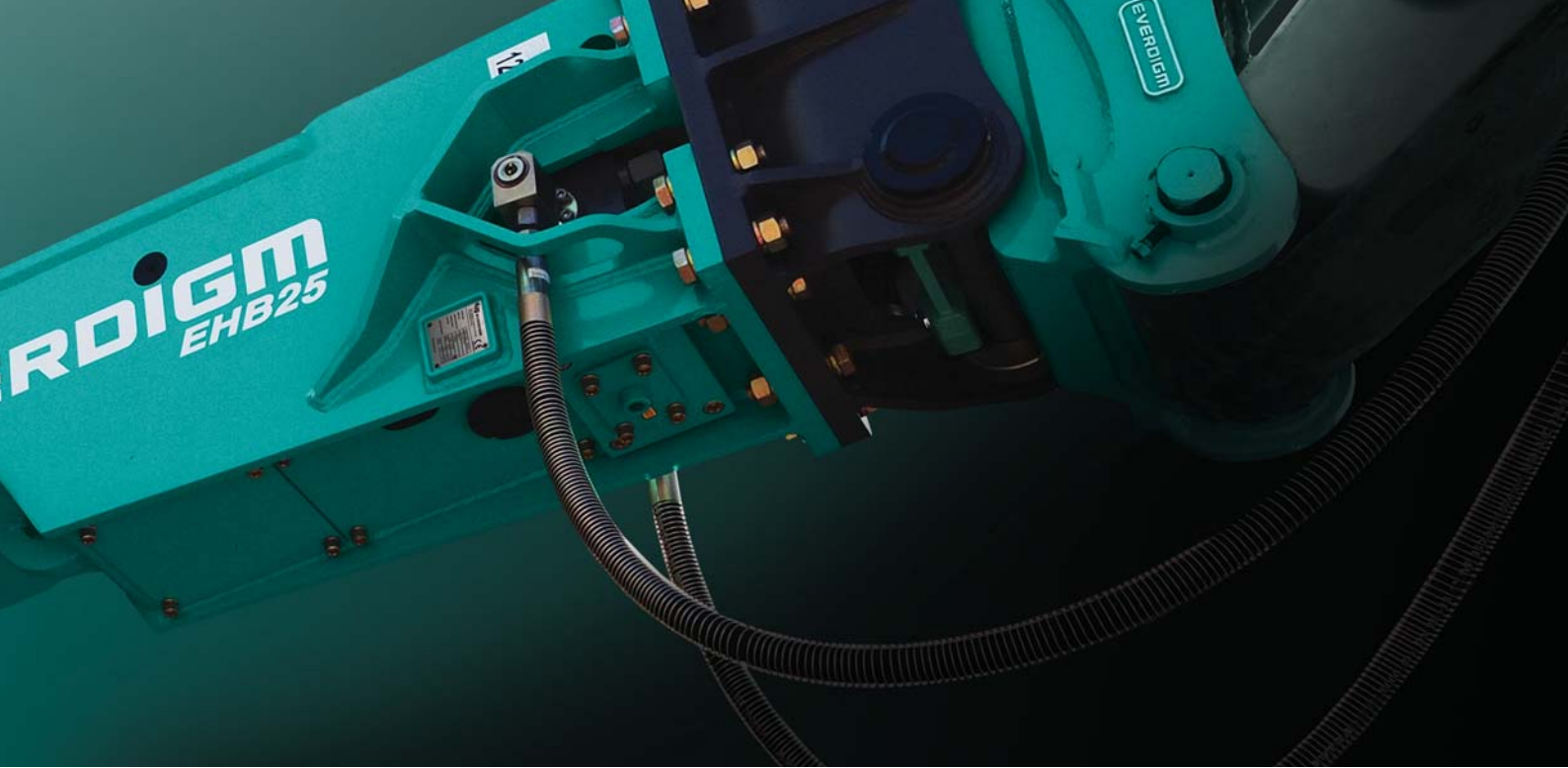

**Skidsteer Loader (EHB04H)&  
Backhoe Loader (EHB05, EHB06)**

EHB04	EHB05	EHB06	EHB10	EHB13	EHB17	EHB20	EHB25	EHB30	EHB40	EHB50	EHB70	EHB04H	EHB05	EHB06
249	328	482	566	1,040	1,393	1,554	1,806	2,477	3,251	4,010	6,500			
217	344	469	563									255		
													312	395
30~50	35~65	45~90	60~110	80~140	110~170	100~150	130~180	170~240	200~280	230~330	320~420	50~75	35~65	45~90
110~140	130~170	130~170	140~180	140~180	160~180	160~180	160~180	165~185	165~185	165~185	165~185	110~140	130~170	130~170
11.7	18.4	25.5	33	42	51	45	54	74	86	102	130	17.5	18.4	25.5
				380~700	350~600	340~550	330~500	310~490	330~450	250~370	280~370			
550~1,000	550~1,000	520~1,000	500~1,000	550~850	500~750	440~700	430~650	400~680	420~600	350~500	370~480	550~1,000	550~1,000	520~1,000
				2,500	2,800	3,500	4,300	6,100	7,600	10,400	13,000			
450	700	1,000	1,350	2,150	2,200	2,800	3,200	4,200	6,000	7,900	10,000	450	700	1,000
58	68	80	93	105	117	125	135	150	165	180	205	58	68	80
2.5~6.0	3.5~8.0	5~11	7~15	12~20	14~24	16~25	20~30	26~35	32~45	40~70	60~110	2.5~8.0	3.5~8.0	5~11
				all	all	all	all	all	all	all	all			
						all	all	all	all	all	all			
						all	all	all	all	all	all			
				BA	BA	BA	BA	BA	BA	BA	BA			
				BA	BA	BA	BA	BA	BA	BA	BA			



[www.everdigm.com](http://www.everdigm.com)

※ Specifications contained in the catalogue may be changed without prior notice for improvement of quality and performance.

© EVERDIGM Corp. Printed in Korea

**Distributed by**

**Head Office & Factory**

332-3, Janggwan-ri, Jincheon-eub, Chungcheongbuk-do, Korea  
Tel\_+82-43-530-3300 Fax\_+82-530-3429

**Sales & Marketing Office**

#1203, Woolim Lion's Valley 2, 680, Gasan-Dong, Geumcheon-Gu, Seoul, Korea  
Tel\_+82-2-801-0800 Fax\_+82-2-801-0899

